



📱 GSM RANGE

CELLCOM PRIME, LITE & I-GATE



 **AES**
G L  B A L

WWW.AESGLOBALONLINE.COM

ACCESS THE FUTURE



CellcomPrime Advanced GSM Intercom

- Calls your home phone and mobiles on roll-over when a visitor presses the call button.
- Never miss a call with mobile calling.
- Works with standard sim cards on contract or prepay.
- Built in time clock to set up automatic opening and closing settings on selected time and days.
- Remote programmable keypad so you don't need to be on site to change codes.
- Optional keypad, proximity reader or both.

Did you know using our optional Vodafone sims can earn you an ongoing revenue of £12 per year as long as the sim remains active? This is for each AES GSM intercom installed.

- All our GSM intercom contain a SIM card which when activated, with your unique installer number can generate recurring revenues for you as a registered installer.
- Call or email sales@aesglobaltelecom.com to be sent sim cards and an information pack. Our to see our current rates, please visit www.aesglobaltelecom.com to find out more.

(Terms and restrictions apply) Please allow up to 24 hours for SIM to become active.





Set automatic gate open & close times.



Do-not-disturb watershed time.



User history log to your phone.



Illuminated call button and keypad.



Add keypad codes by App.



Issue time restricted codes.



High gain antenna as standard!



2x Relays

Network codes for products:

4GE = Europe

4GA = USA

4GAU = Australia & NZ



		Technical Details	
Dial Out Numbers	4	Relays	2
Permanent Codes	200	Relay Type	N/C and N/O
Time Restricted Codes	20	Relay Load	2 amps, 24v ac max
Temporary Codes	30	Power Consumption	300mA on dial out, 2amp peak demand
Automatic Trigger Events per Week	40	Modem Models	4G Europe, 4G USA, 4G AUS/NZ
Caller ID Numbers	100	Power Supply	24v dc (24v 2A dc adaptor included)
Time Restricted Caller ID Numbers	20		



PRIME6-IMP/4GE

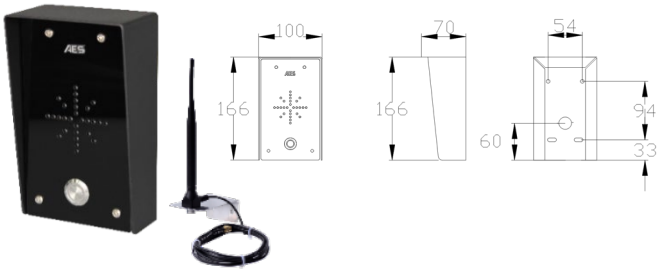

PRIME6-IMPK/4GE

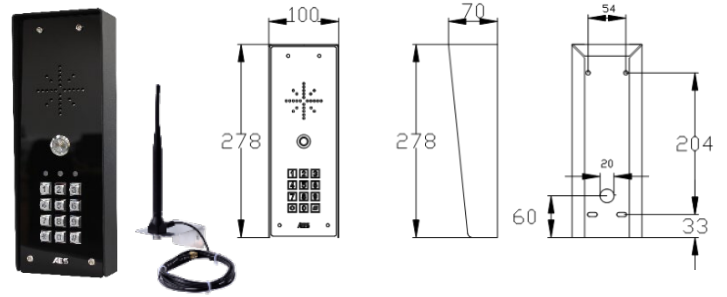

Sleek, all black call points, constructed from marine grade stainless steel, powder coated aluminium hood and gloss black toughened acrylic faceplate trim.

PRIME6-IMP-PED/4GE

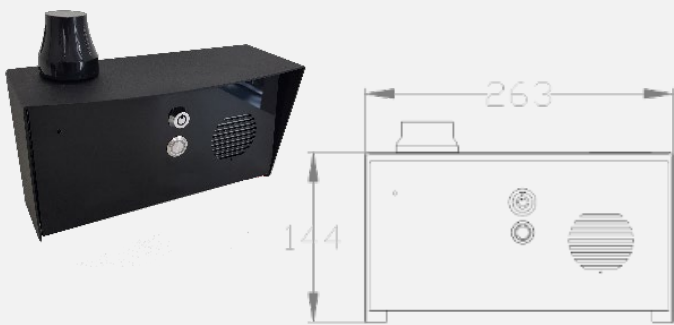

PRIME6-IMPK-PED/4GE

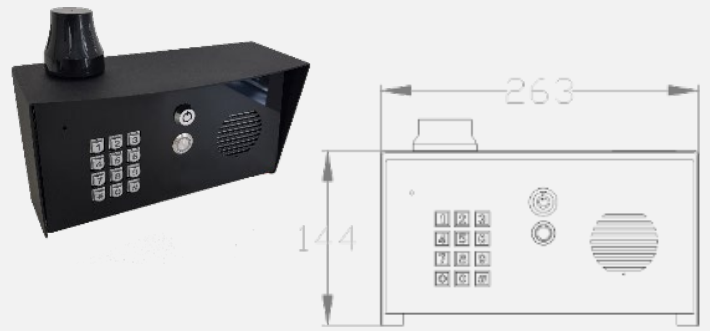

Pedestal mountable, high volume call points, constructed from marine grade stainless steel, powder coated aluminium hood and gloss black toughened acrylic faceplate trim.

PRIME6-AB/4GE

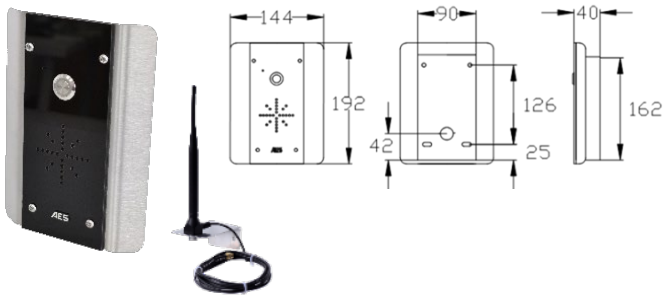

PRIME6-ABK/4GE

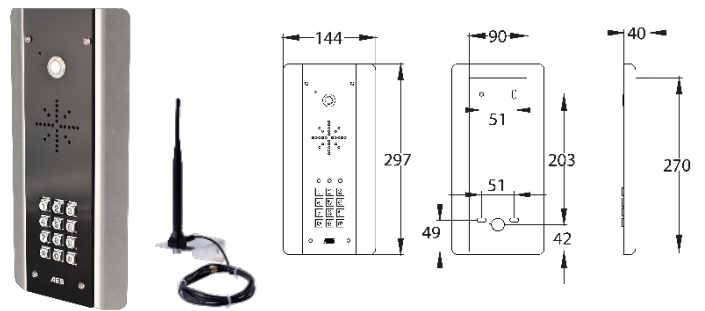

Stylish, modern curved profile call points with wall backlighting effect in neon blue. Constructed from 100% marine grade stainless steel and toughened acrylic face trim.

PRIME6-AS/4GE

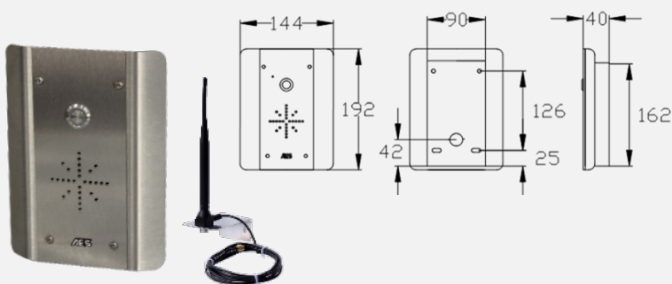

PRIME6-ASK/4GE

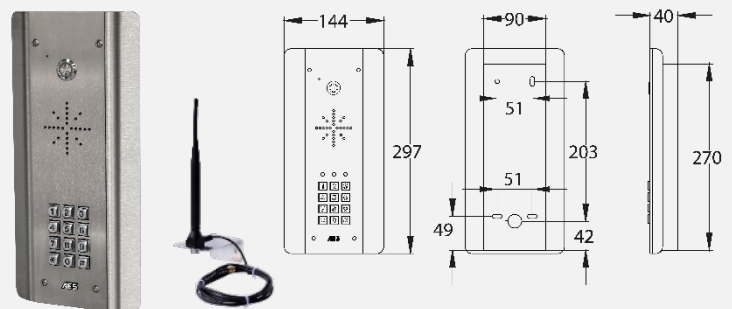

Stylish curved architectural models in an attractive and rugged all brushed BS316 marine grade stainless steel with modern cool white back lighting illumination.

Flush Mount Options



PRIME6-FB/4GE

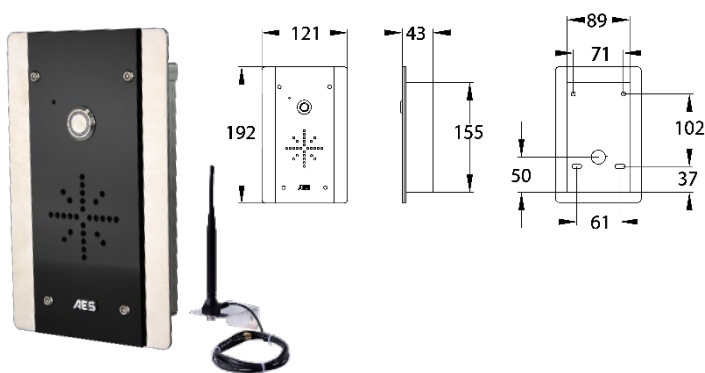

PRIME6-FBK/4GE

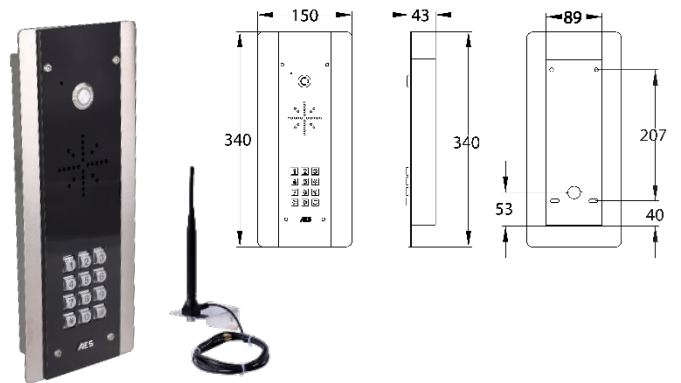

Stylish, flush profile call points with neon blue lighting. Constructed from 100% marine grade stainless steel and toughened acrylic face trim. Non-Keypad & Keypad Models.

PRIME6-FS/4GE

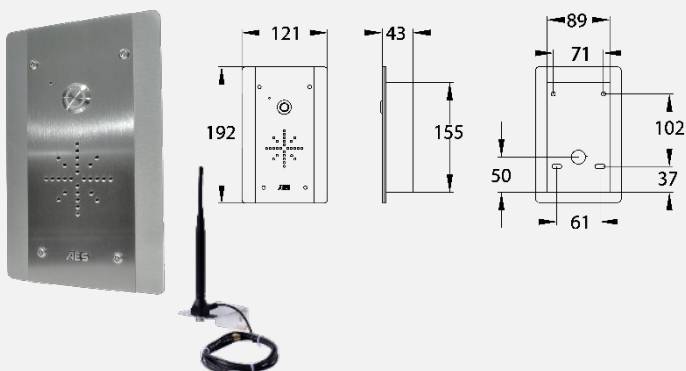

PRIME6-FSK/4GE

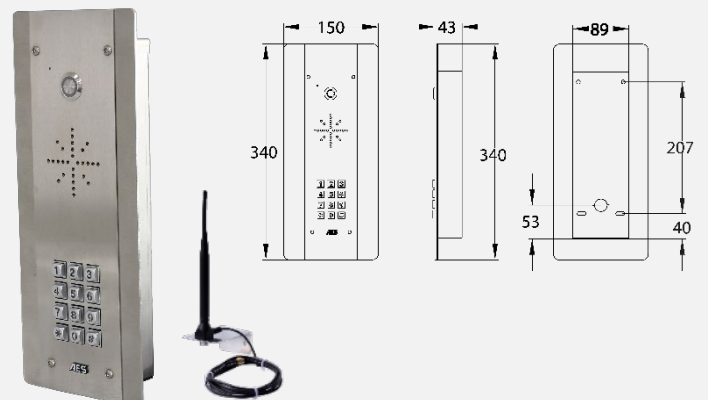

Stylish flush models in an attractive and rugged all brushed BS316 marine grade stainless steel with modern cool white lighting. Non-Keypad & Keypad Models.

CellcomProx

GSM Panels with PROX READERS



Add up to 200 cards or tags to intercom remotely by SMS text or app (30 temporary users).



Add up to 20 time restricted tags or cards by app!



The PROX panels have the same technical details as the NON prox panels.

PROXCARD-125K-AES



- 125KHz fixed 10 digit code Card.
- Add to intercom remotely by SMS text or APP.
- Also available in packs of 10 & 50.

AES-PROX-TAG



- 125KHz fixed 10 digit code TAG.
- Add to intercom remotely by SMS text or APP.
- Available in packs of 10, 25, 50 & 100.

PRIME6-PX-IMP/4GE

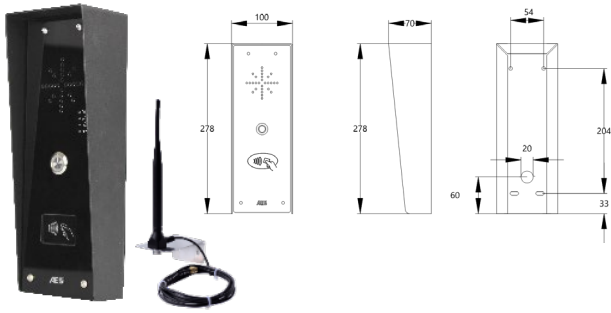

PRIME6-PX-IMPK/4GE

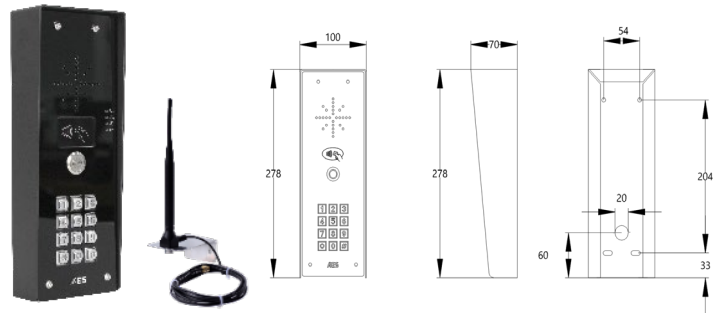

Ultra stylish all black panel with textured powder coated aluminium hood and gloss black acrylic facia trim over a tough metal back plate. Complete with modern white illuminated push button and integrated Prox reader. Kits complete with 3 proximity cards with additional cards available to purchase. Non-Keypad & Keypad Models.

PRIME6-PX-AB/4GE



PRIME6-PX-ABK/4GE

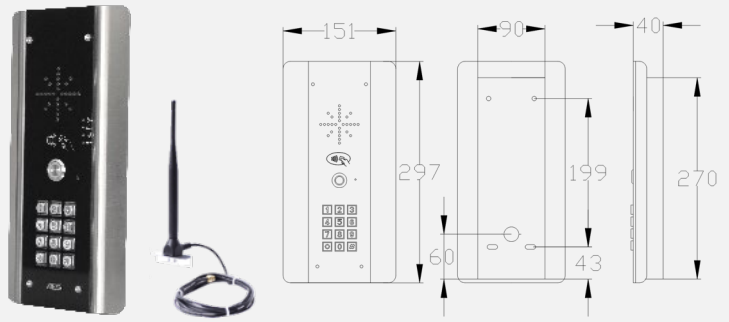

Stylish curved architectural model. Constructed from BS316 marine grade stainless steel and finished with gloss black acrylic trim. Complete with modern blue illuminated push button and integrated Prox reader. Kits complete with 3 proximity cards with additional cards available to purchase. Non-Keypad & Keypad Models.

PRIME6-PX-AS/4GE

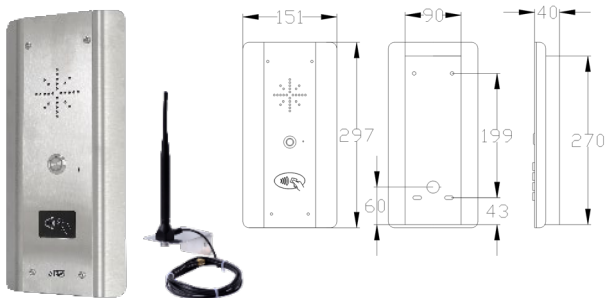

PRIME6-PX-ASK/4GE

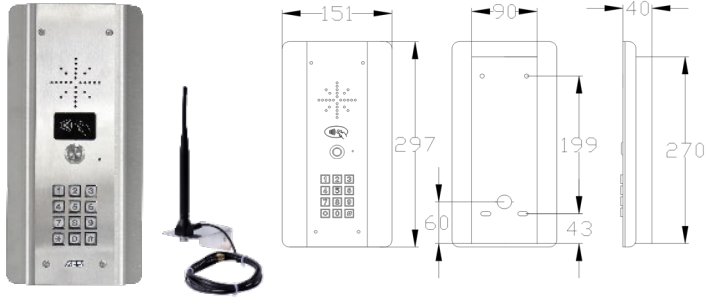

Stylish curved architectural model. Constructed from BS316 marine grade stainless steel. Complete with white illuminated push button and integrated Prox reader. Kits complete with 3 proximity cards with additional cards available to purchase. Non-Keypad & Keypad Models.

PRIME6-PX-IMP-PED/4GE

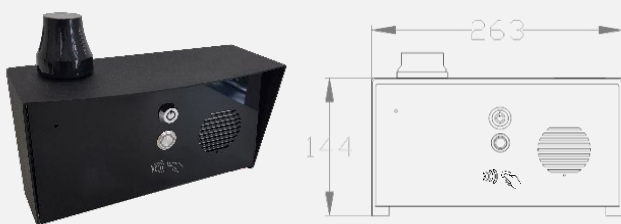

PRIME6-PX-IMPK-PED/4GE

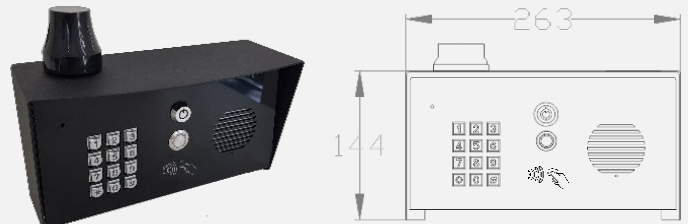

Industrial version for pedestal mount, vehicle entrances, trucks and loud industrial applications. BS316 marine grade stainless steel construction with gloss black face trim. With built in proximity reader. Non-Keypad & Keypad Models.

PROX Flush Mount Options



PRIME6-PX-FB/4GE



PRIME6-PX-FBK/4GE



Stylish flush call points with neon blue lighting. Constructed from 100% marine grade stainless steel and toughened acrylic face trim. Non-Keypad & Keypad Models.

PRIME6-PX-FS/4GE



PRIME6-PX-FSK/4GE



Stylish Flush models in an attractive and rugged all brushed BS316 marine grade stainless steel with modern cool white lighting. Non-Keypad & Keypad Models.

CellcomPrime

G S M N O T O U C H I N T E R C O M S



PRIME6-AB-NT/4GE

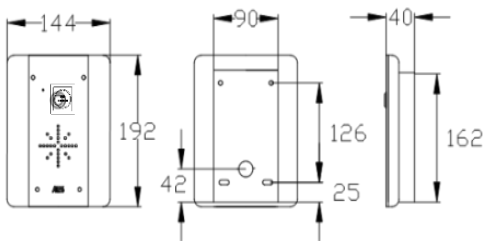

— Architectural model with no touch sensor call button.

PRIME6-PX-AB-NT/4GE

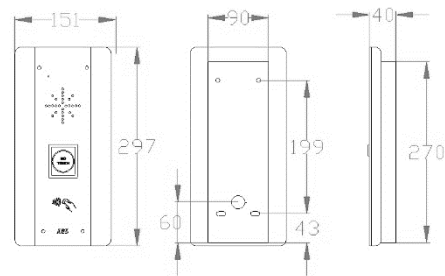

— Architectural **PROX** model with no touch sensor call button.

NO TOUCH SENSOR BUTTON



BLUE Light Standby



Green light Active

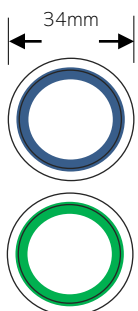

Button Technical Details			
Dimensions	34mm	Operating Temp	-20c~+55c (14-131F)
Contact Rate:	3A/125-250VAC	Operating Humidity	0-95% (relative humidity)
Power	12-24VDC	Detection Range	5-10cm
Waterproof	IP68	LED indicator	BLUE LED (Standby) GREEN (Active)

PRIME6 6E Multi-call Station System

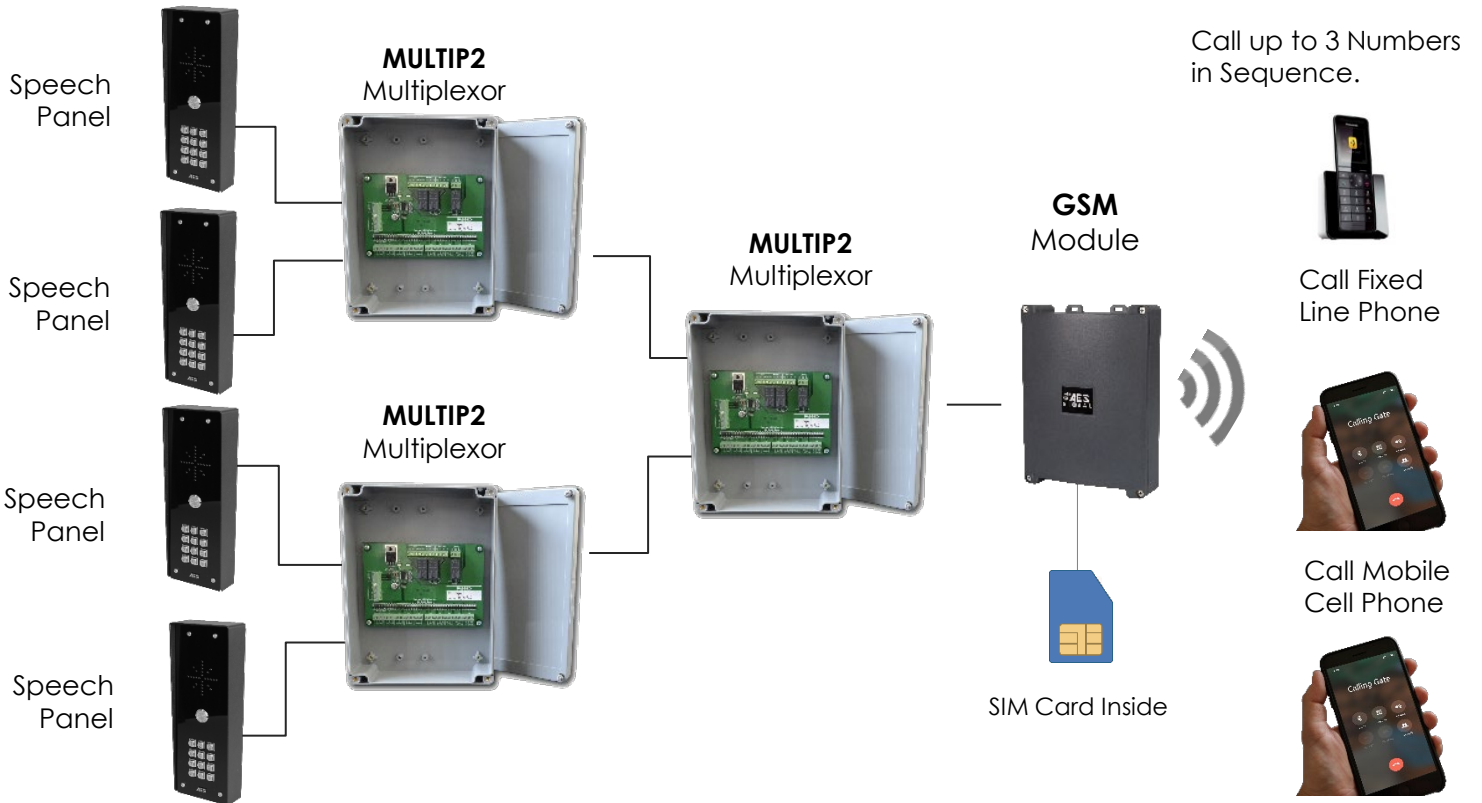
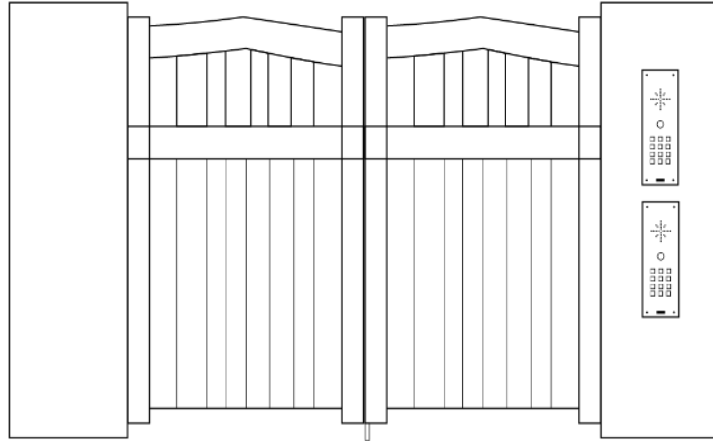

Call Panel Options



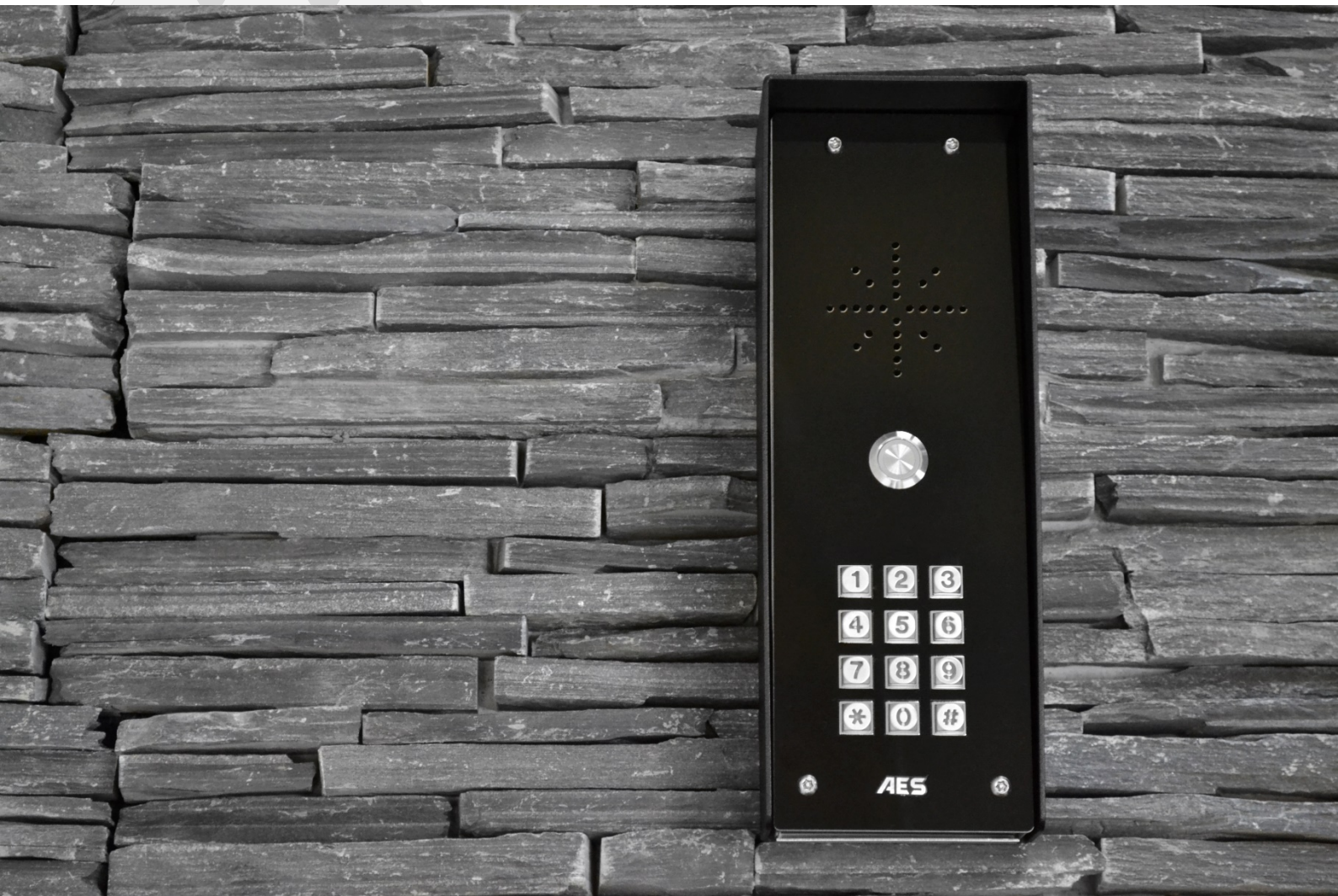

CellcomPrime

Slave Devices

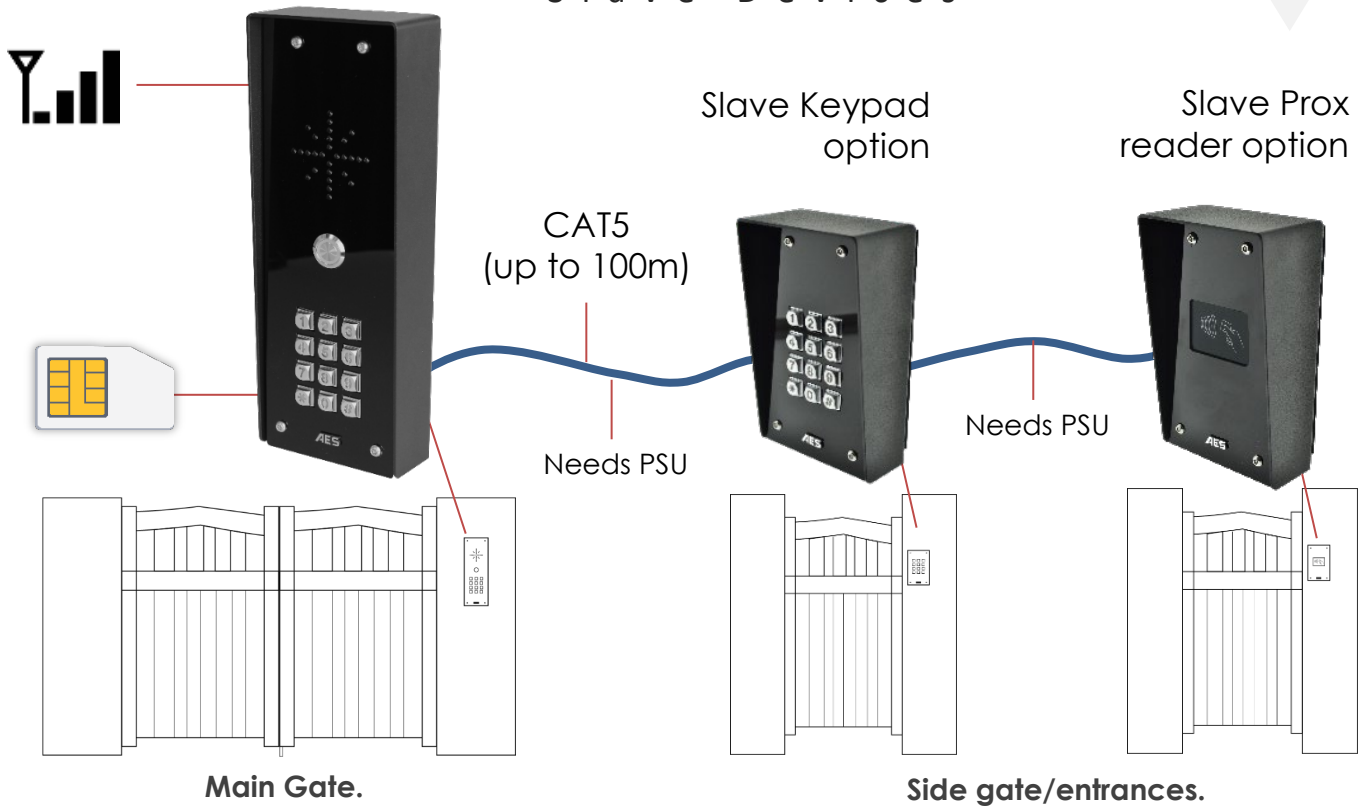

Architectural Slave Devices

PRIME-SLV-KP-AB

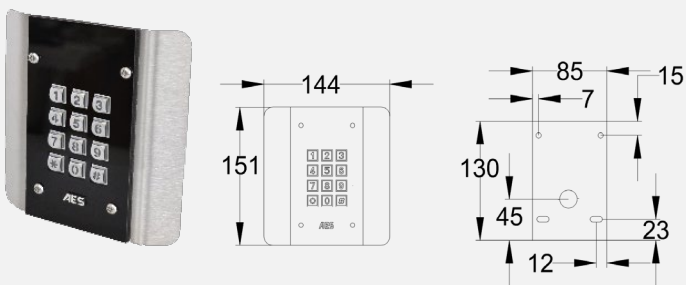

- Architectural Slave Keypad.
- Works with any "PRIME-6" product.

PRIME-SLV-PX-AB

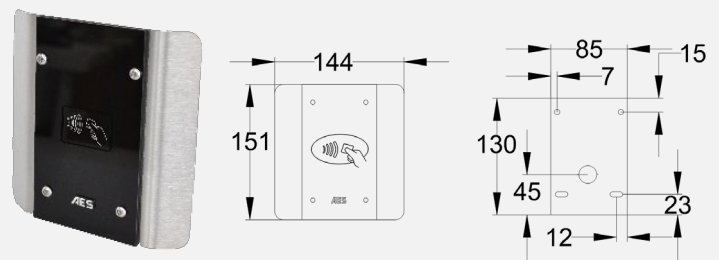

- Architectural Slave Prox Reader.
- Works with any "PRIME-6" product.

PRIME-SLV-KP-AS

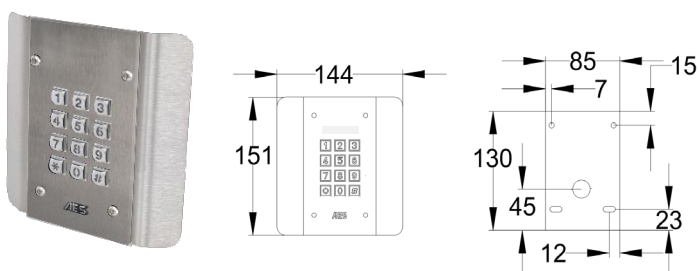

- Architectural Slave Keypad.
- Works with any "PRIME-6" product.

PRIME-SLV-PX-AS

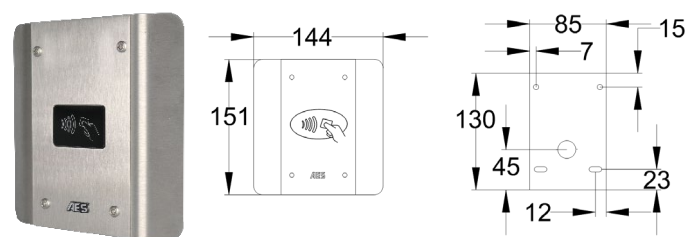

- Architectural Slave Prox Reader.
- Works with any "PRIME-6" product.

Imperial Slave Devices

PRIME-SLV-KP-IMP

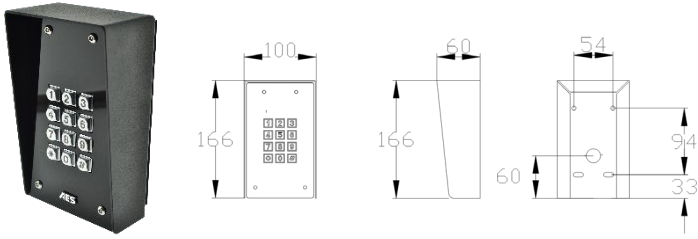

- Imperial Slave Keypad.
- Works with any "PRIME-6" product.

PRIME-SLV-PX-IMP

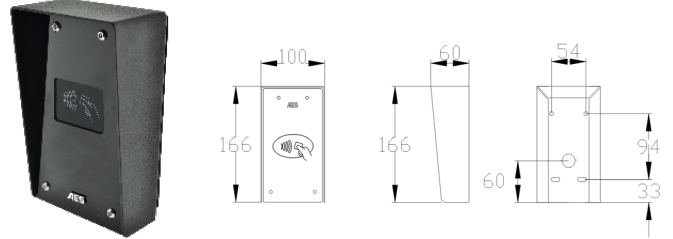

- Imperial Slave Prox Reader.
- Works with any "PRIME-6" product.



CellcomPrime

MULTI-BUTTON SYSTEM

PRIME6-IMPK2

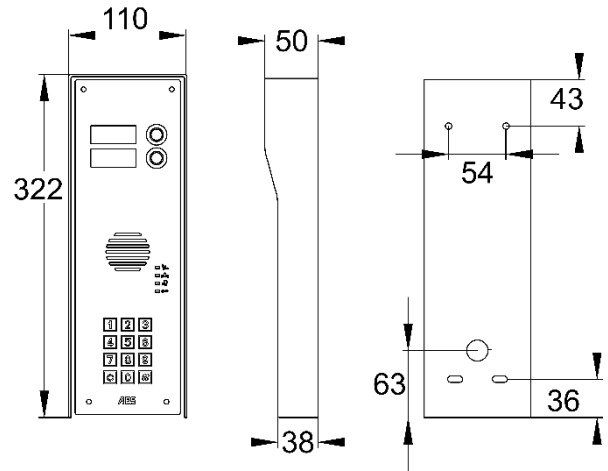

PRIME6-IMPK3

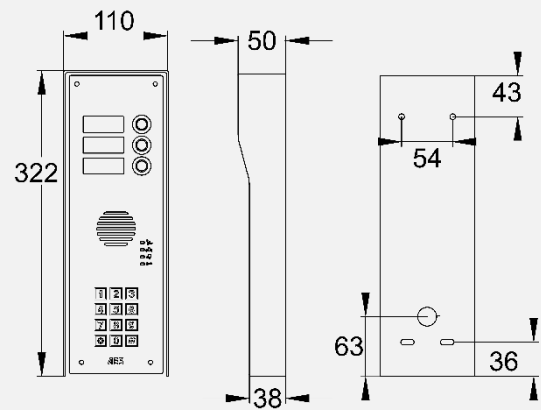

PRIME6-IMPK4

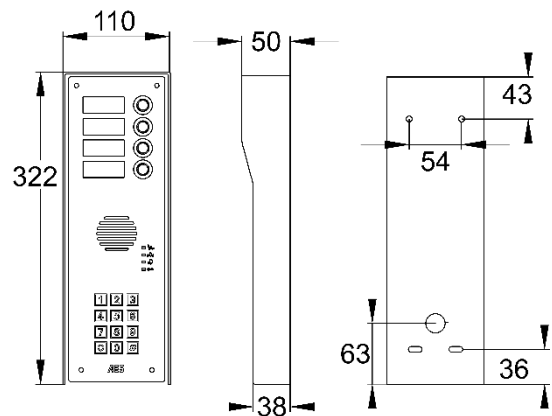

PRIME6-**XX** N / **YYY**

IMPK = All black panel with textured powder coated aluminium hood and gloss black acrylic facia trim over a tough metal back plate.

- 2** = Two button
- 3** = Three button
- 4** = Four button

- 4GE** = Euro 4G model
- 4GA** = USA 4G model
- 4GAU** = AU/NZ 4G model



PROX panels options available

i - G A T E

A d v a n c e d G S M G a t e O p e n e r s



I - G A T E P R I M E

IGATE-PRIME/4GA	4G capability (USA)
IGATE-PRIME/4GE	4G capability (Europe)
IGATE-PRIME/4GAU	4G capability (Australia/NZ)

- GSM gate opener with IOS & Android apps.
- Stores up to 100 numbers for caller ID access (ring gates to open).
- Trigger, latch and unlatch gates by SMS text or with app.
- 2 x Volt free momentary relay outputs.
- Simple programming by SMS text or app.
- Check if gates are opened or closed!
- Can also ring 4 phones when alarm or gates are triggered.
- Check stored numbers by SMS.
- Auto call feature to schedule outgoing call (prevents SIM card being deactivated).
- Auto relay.

**Includes 7
day time
clock**



**Activity log
feature.**



I - G A T E 1 2 0 0

IGATE-1200/4GA	4G capability (USA)
IGATE-1200/4GE	4G capability (Europe)
IGATE-1200/4GAU	4G capability (Australia/NZ)

- **Stores 1200 numbers for caller ID access.**
- GSM gate opener with IOS & Android apps.
- Apps available with hold open buttons (for gate systems supporting this feature).
- Check stored numbers by SMS.
- SMS passcode access for non stored numbers.
- Trigger, latch and unlatch gates by SMS text or with app.
- Simple programming by SMS text or app.

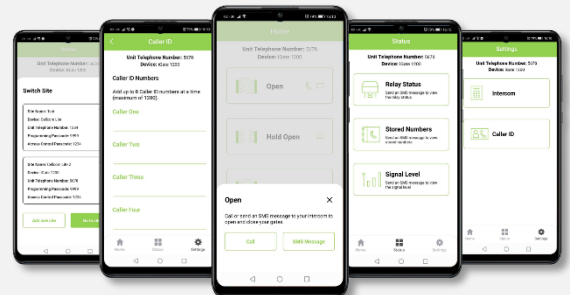

NEW, User friendly app. To help homeowners control their GSM intercom and gates/doors.

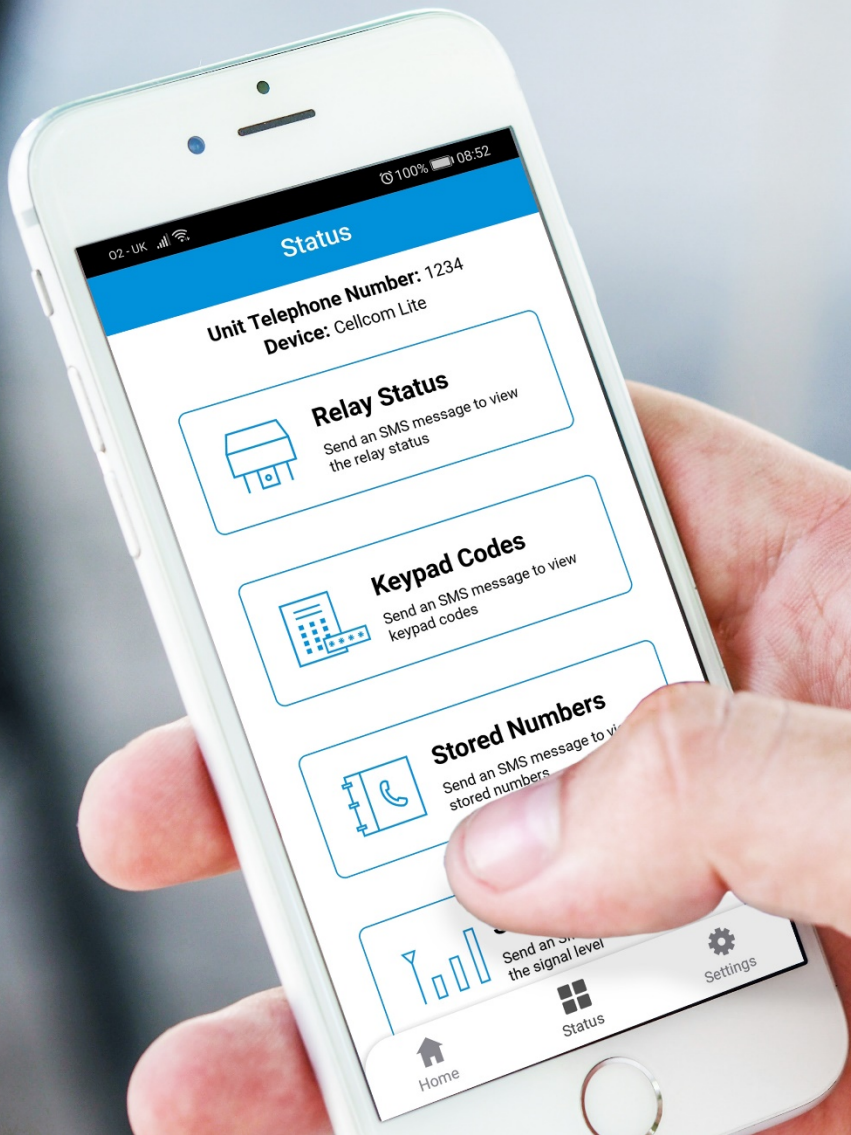



CELLCOM *lite*

Simple, Effective GSM Intercom

LITE-GSM-KP/4GE	4G	Europe
LITE-GSM-KP/4GA	4G	USA
LITE-GSM-KP/4GAU	4G	Australia & NZ

- Calls your home phone and mobiles on roll-over when visitor presses call button.
- Never miss a visitor with mobile calling.
- Works with any standard contract or Pre-Pay GSM Nano SIM card. (sim included UK/IRE only)
- **NEW free** AES Lite app for installer programming.
- Homeowner can use app to trigger gates.



Technical Details

Dial Out Numbers	3	Relays	1
Permanent Codes	25	Relay Type	N/C and N/O
Permanent Caller ID Numbers	25	Relay Load	2 amps, 24v ac max
Power Consumption	100mA on dial out, 220mA peak demand	Modem Models	4G Europe, 4G USA, 4G AUS/NZ
Power Supply	24v dc (24v 2A dc adaptor included)		

Home Owner /User App

- Switch site function for programming and navigating multiple sites.
- Program dial out numbers and other related features.
- Speed dial or send SMS to control gates.
- Check stored information and current status of intercom.
- Program multiple keypad codes in one SMS.

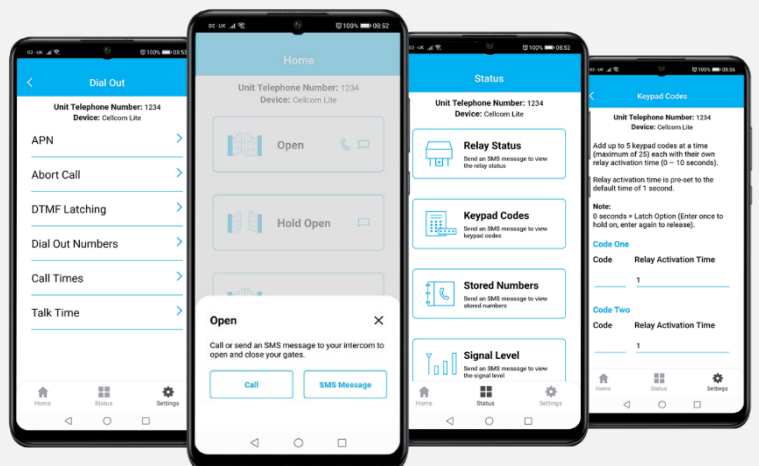

Multicom Classic



Multi Apartment Intercom!



- Calls up to 500 families from a single SIM card.
- Visitors can scroll for residents, or enter apartment number to call.
- Dials up to 3 phone numbers per family on roll over.
- 4G Enabled.
- HD voice with VOLTE*.
- Programme via app or software

4GE = Europe
4GA = USA
4GAU = Australia & NZ



MULTI-CLASSIC-IMPK/4GE

Sleek, all black panel, marine grade stainless steel, powder coated aluminium hood and gloss black acrylic faceplate, with keypad. Built in prox reader.

MULTI-CLASSIC-SSK/4GE

Hooded, all stainless model in marine grade stainless steel, with keypad. Built in prox reader.

MULTI-CLASSIC-FBK/4GE

Flush model in marine grade stainless steel, with gloss black acrylic faceplate, with keypad. With built in prox reader.

MULTI-CLASSIC-FSK/4GE

Flush model all stainless model in marine grade stainless steel, with keypad. Built in prox reader.

Multicom LITE & mini

Welcome to 232 Washington Drive Apartments	
1. Jones	11. Harrington
2. Smith	12. Waters
3. Edens	13. Anderson
4. Murray	14. Boucher
5. Hopper	15. White
6. Hargrove	16. Evans
7. Byers	17. Owens
8. Hermann	18. Brown
9. Redfield	19. Rooney
10. Flintoff	20. Potter
To CALL, enter Apartment number, then press #	
To open, enter door code, then press *	

Welcome to 232 Washington Drive Apartments

 **Installer LOGO**

To CALL, enter Apartment number, then press #

To open, enter door code, then press *



Customisable name directory – free template downloadable from our website:
www.aesglobalonline.com/gsm-resources

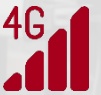

MULTI-LITE-FBK/4GE

Flush panel option available.

MULTI-LITE-IMPK/4GE

- **Multicom Life** - 4G LTE capable, GSM multiapartment intercom.
- Programmable remotely by free APP.
- Up to 30 family using illuminated directory screen, or up to 100 family direct dialling from the keypad.

4GE = Europe
4GA = USA
4GAU = Australia & NZ

Free programming app downloadable from the App Store and Google Play store.



MULTI-MINI-IMPK/4GE

- **Multicom mini** - 4G GSM multi-apartment intercom, in imperial finish.
- Up to 20 family direct dialling from the keypad.
- Features an illuminated nameplate with led indicators and illuminated keypad.





Follow us on social media!



www.aesglobalonline.com
E. sales@aesglobalonline.com
TEL. +44(0)288 639 0693

